

PQS**PRACTICAL QUALITY SYSTEMS**
*Fast Custom Manufacturing - Nationwide Installation Services***Mini Office Enclosure for Counter Tops 72"W X 64"H PN 81013**

Installs directly on any counter top or table. Includes a locking Roll Up Door, a light, an 18"W Wire Rack Shelf, a 62"H interior Shelving System with 2- 60"W X 18"D Wire Rack Shelves and 1- 18"W Side Shelf, a Modular Ventilation System with 8 Fans, an outlet strip, cable management rings, a VESA monitor mount, 4- Leveling Legs, 9-Bin Boxes 5 3/8"Lx4 1/8"Wx3"H, 9-Bin Boxes 7 3/8"Lx4 1/8"Wx3"H and 2- 38"W Bin Box Mounting Bars.



Need it installed? We have nationwide professional installation services available. Just contact us!

info@practicalqualitysystems.com

WWW.PRACTICALQUALITYSYSTEMS.COM

(818) 993-1022

ALL PRODUCTS PATENT PENDING

Introduction to Enclosures

Our Enclosures bridge the gap between offices and cubicles to create secure spaces for people and equipment that can be installed in permanent or temporary applications.

We currently manufacture four basic sizes of Enclosures: All Enclosures are 30" deep and are available in widths of 45" and 72" and heights of 36" and 64". When equipped with Side Supports; the 36"H Enclosures are approximately 64" high, and the 64"H Enclosures are approximately 95" high.

Add a 30" wide Side Table PN 60089 or a full sized 45" or 72" wide Work Table for more space next to an Enclosure.

These Enclosures are constructed entirely of stainless steel, galvanized steel and anodized aluminum to resist corrosion and harsh environments. Not just simple boxes; these Enclosures are engineered with multiple interior structural support members. Each includes three beams across the bottom panel, three beams and a double walled header across the top panel, two pillars on each side and a rear panel assembly that is double walled. The top and bottom panel covers are further reinforced with welded corners.

Value is added across our entire line of Enclosures, Work Tables and Shelving Systems because each has been designed to be modular and fully compatible with our line of optional equipment. Enclosures can be configured to be installed on Counter tops, Free Standing, Wheeled, Wall mounted or Recessed into a Wall. All of our Free Standing Enclosures and Work Tables can be connected together side to side, corner to corner or back to back. These versatile features allow you to create a large variety of configurations to fit your space.

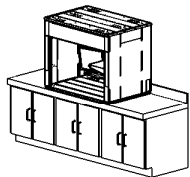

COUNTERTOP

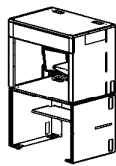

FREE STANDING

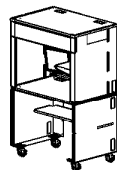

WHEELED

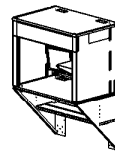

WALL MOUNTED

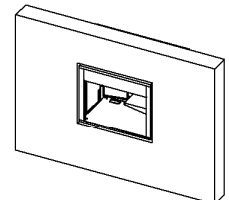

IN WALL

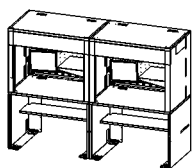

SIDE BY SIDE

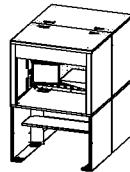

BACK TO BACK

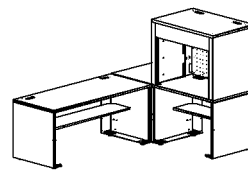

CORNER TO CORNER

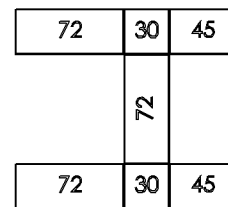
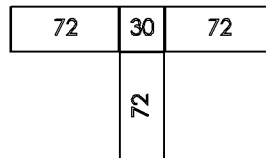
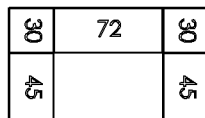
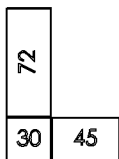

CONFIGURATION EXAMPLES

Product Specifications

info@practicalqualitysystems.com

WWW.PRACTICALQUALITYSYSTEMS.COM

(818) 993-1022

ALL PRODUCTS PATENT PENDING

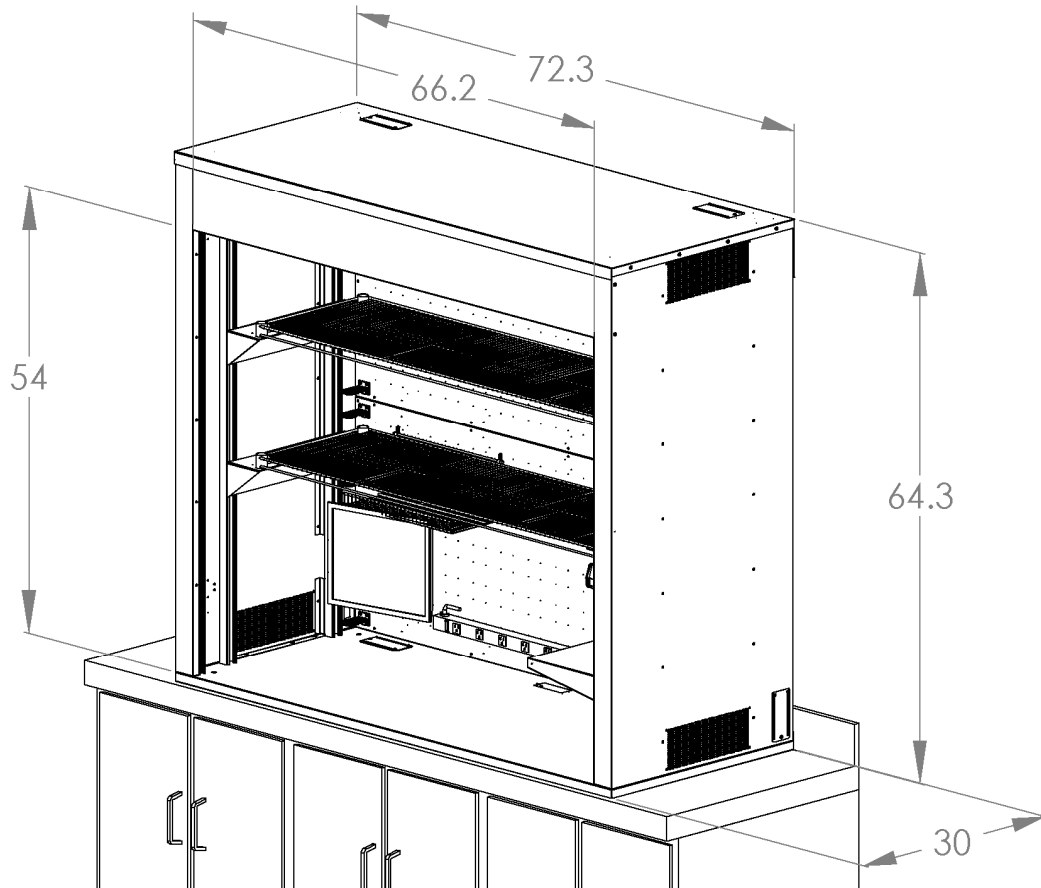

Interior Space:

70.39"L x 26.87"D x 55.06"H (to bottom of door housing) & 56.87"H (to bottom of vent box) or about 60.26 cubic feet

Weight:

72 x 64 Countertop Bare = approx 445 lbs. Note: This weight does not include any options or accessories. Each Enclosure will probably contain at least 50 lbs. of accessories.

Engineering Drawing Reference Notes

To view and manipulate 3D models of any assembly; visit www.edrawingsviewer.com and download the free eDrawings viewer software, then open the eDrawing format files (.EASM) found in our Engineering Drawings folders.

For more product dimensional specifications; download the Engineering Drawings folder for files in DWG, PDF and EASM formats on our website from the tool bar on the individual product pages or from our Product Resources page.

Refer to manual 10010101-UM for assembly and installation instructions

User manuals are available for download in PDF format on our website from the tool bar on the individual product pages or from our Product Resources page.

Standard Features:

Roll Up Door

The sectional Roll Up Door that is included on all Enclosures doesn't require any room to swing open; instead it coils around a load balancer unit that is installed inside of housing behind the header above the opening of the Enclosure. The load balancer greatly reduces the weight of the door to make opening and closing the door smooth and easy. The doors and tracks are constructed of sturdy, extruded anodized aluminum. The door panels feature self lubricating guides and integral hinges. All doors include a rugged keyed lock that extends two heavy duty latches into the door track on both sides.

Cable Path Openings on 72"W Enclosures

All 72"W Enclosures feature eight large and convenient Cable Path Openings with fully adjustable covers make the installing cabling and power cords quick and easy. There are two openings near the left and right rear corners of the top panel and one in the middle, two near the left and right rear corners and one in the middle of the bottom panel and one opening on each of the lower rear corners of the left and right side panels.

Enclosure Top Panel

The Enclosure top panel is made of 18 gauge Stainless Steel with welded corners for added strength. It has been pre marked with small indentations that mark the locations of the 5/16" holes that are needed for adding optional Vertical Shelf Standards to support shelves or an Upper Cabinet.

Inner Rear Panel

The Inner Rear Panel of all Enclosures has been predrilled to permit easy attachment either vertically and horizontally of multiple Cat5E Network Patch panels, 66M type Telephone Terminal blocks or any other device that uses an industry standard 89D bracket. It is also predrilled to allow attachment of Cable Management Rings, 18" Wire Rack Shelves or Bin Box Mounting Bars.

Insert Plates

These 1/4" thick steel "Insert Plates" are used to attach the main structural components together. They are installed in each of the four corners of the support C beams in the bottom panels of all Enclosures and Table Tops. These plates create "hard points" that add extra strength for attachment of Side Supports to the bottom panels of Enclosures or the undersides Work Tables. They also are used to attach Leveling Legs or caster wheels directly to Enclosures or to Side Supports for Enclosures or Work Tables.

Leveling Legs and Optional Caster Wheels

All Enclosures feature adjustable Leveling Legs that allow quick and easy leveling on uneven surfaces. The foot of each leveling leg includes a movable mounting strap that swivels around the leg and permits simplified attachment to the mounting surface. If a mobile solution is desired, simply remove the Leveling Legs and add the optional Caster Wheel kit- PN 60103. These wheels are intended for temporary use and attach directly to the bottom of the Enclosure or to the Side Supports. They feature locking brake mechanisms and swivel a full 360 degrees to allow easy movement in any direction.

Included Options:**Fluorescent Strip Lights 72"W X 64"H Enclosures**

Includes an energy efficient, low profile fluorescent strip lights that brightens the interior of the Enclosure without glare. A 42" wide light is installed below the lowest Wire Rack Shelf. Additional strip lights can be added below the Roll Up Door balancer cover or below any Wire Rack Shelf if desired.

18" W Wire Rack Shelf

Includes an 18"W X 8 ½"D wide interior Wire Rack Shelf for small, hard to mount peripheral equipment. Install network switches, routers, KVM switches and modems right on top of the shelf and then drop the cabling right through the shelf at any point. The Inner Rear Panel of all Enclosures is pre drilled to allow industry standard 89D type 12 Port Cat5E patch panels to be mounted horizontally right below the 18" Wire Rack Shelf so that jumper cables can be easily routed up to a network switch that is installed on the shelf above.

Modular Ventilation System with 8 - fans for 72"W X 64"H Enclosures

All 72"W X 64"H Enclosures come standard with one Modular Ventilation System that has 8 fans. An additional Modular Ventilation System can be added that can be equipped with up to eight fans for a maximum total of sixteen (16) fans for any 72"W Enclosure. The ventilation systems are designed to pull cooler air in from the lower slotted inlet sections on the sides, then the air flows across the warm equipment and is drawn into the ventilation system near the top, rear center area of the Enclosure by the fans which then exhaust the warmed air out through the upper slotted outlet sections.

Interior Shelving System with 2- Wire Rack Shelves and 1 - 18"W Side Shelf for 72"W X 64"H Enclosures

A 54"H interior Shelving System that includes 2- 60"W X 18"D Wire Rack Shelves that feature a bright chrome finish and can support up to 75lbs each. Also includes an 18"W X 19"D Side Shelf that's perfect for supporting items such as fax machines and small printers. The vertical positions of the shelves are easily adjusted with common tools. The 18" wide Side Shelf is installed on the left side of the Enclosure as shipped from the factory, but it can easily be relocated to shelving system on the right side if desired. Both the Shelving System and the Side Shelf are made of heavy gauge galvanized steel.

Multiple Outlet Power Strip

Includes a Multiple Outlet Power Strip that is installed across bottom of the Inner Back Panel. Features an all metal housing with several grounded outlets that are spaced far enough apart to easily accommodate large power transformers. Includes a circuit breaker, mounting tabs on each end and 6 foot grounded power cord.

Cable Management Rings

Includes multiple large cable management rings that support cabling and power cords vertically and horizontally on the Inner Back Panel. They are molded of high impact plastic into a sturdy "C" shape design that incorporates a resilient spring opening on one side. These cable management rings make it easy to organize all of the cabling and power cords. The rings can be easily removed and relocated to any of many other predrilled vertical or horizontal positions if needed.

Included Options Continued:**A VESA Monitor Mount for interior pillars**

Includes a 75/100 mm VESA Monitor Mounting Kit that can be installed on the support pillars at either the right or left sides at either the front or rear of the inside of the Enclosure. The mount features two axes of movement that can be adjusted without tools and it can support flat panel monitors up to 24".

Bin Boxes and Mounting Bars

Includes a number of handy Bin Boxes and Mounting Bars that are great for organizing small items. (For bin box and mounting bar specifications refer to the product short description) These bins have a built in hanging edge along the back and are molded of high-impact polypropylene. Their sturdy, one-piece construction is water, rust and corrosion-proof and they are unaffected by grease, oils, weak acids or alkalis. They feature a Curved-bottom hopper front which makes it easy to retrieve small items. Color varies. Some Bin Box Mounting Bars are pre installed across the rear inner panel at the factory; but they can easily be relocated to multiple predrilled locations on the Inner Rear Panel. Other Bin Box Mounting Bars are attached to the Channel Strut of Side Shelving Systems; the height position of these bars can be easily adjusted if desired.

List of all available options and accessories for Enclosures:

Select a preconfigured Enclosure or use our line of Options and Accessories to create a customized solution that fits your exact needs.

Pull Out Work Surface

Full size File Drawers

Half Size Drawers (2)

All in One Drawer Set

Drawer Set with Combo Frame (3)

19" Rack Mount Drawer Kit for Enclosure interiors

19" Rack Mount Drawer Kit w/ MVS for Lower Cabinets

Lock Bar Kits (2)

Drawer Center Leg

VESA Monitor and POS Printer Mounts for Enclosure interiors, Work Tables or Shelving Systems (4)

Cross bars for Shelving Systems for Monitor or Printer Mounts (3)

Bin Boxes (3)

Bin Box Mounting Bars for Bin Boxes for Shelving Systems (2)

Bin Box Mounting Bars for Enclosure interiors (3)

Shelving System 30" H for above 36" H Enclosures (2)

Enclosure Interior Wire Rack Shelf Kits (2)

Enclosure Interior 18"W Side Shelf Kits (2)

Additional Upper Shelf Kits (4)

Additional Lower Shelf Kits (2)

Side Table and Corner Junction

Wall Mount Kits for Enclosures (2)

Free Standing Kits for Counter Top Enclosures (2)

Caster Wheel Kit

Lower Cabinet Kits for Counter Top Enclosures (3)

Lower Cabinet Kits for Free Standing Enclosures or Work Tables (3)

Upper Cabinet Kits (2)

Network Data Patch Panels and Telephone Terminal Blocks (2)

Fluorescent Strip Lights (2)

Multiple Outlet Power Strips 36"L (2)

Modular Ventilation Systems and Fans (2)